

Audio Amplification Transistor

Features and Benefits

- LAPT (High frequency multi emitter transistor)
- Small package (TO-3P)
- High power handling capacity, 160 W
- Improved sound output by reduced on-chip impedance
- Complementary to 2SC6145A

Package: 3-Lead TO-3P



Not to scale

Description

Sanken LAPT transistors have an innovative design, produced by adapting advancements in the unique Sanken thin-wafer production technology. These PNP power transistors achieve faster power-up by decreasing thermal resistance, and provide a higher avalanche breakdown voltage rating. The high power-handling capacity of the TO-3P package allows a smaller footprint on the circuit board layout. This series of transistors is very well suited not only for multichannel applications for AV (audio-visual) amplifiers and receivers, but also for parallel connection applications for PA (professional audio system) amplifiers.

Applications include the following:

- Single transistors for audio amplifiers
- Home audio amplifiers
- Professional audio amplifiers
- Automobile audio amplifiers
- Audio market
- Single transistors for general purpose

Equivalent Circuit

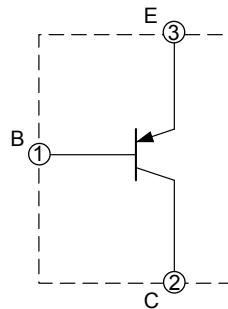

Selection Guide

Part Number	Type	h_{FE} Rating	Packing
2SA2223A*	PNP	Range R: 40 to 80	30 pieces per tube
		Range O: 50 to 100	
		Range Y: 70 to 140	

*Specify h_{FE} range when ordering.

Absolute Maximum Ratings at $T_A = 25^\circ\text{C}$

Characteristic	Symbol	Remarks	Rating	Unit
Collector-Base Voltage	V_{CBO}		-260	V
Collector-Emitter Voltage	V_{CEO}		-260	V
Emitter-Base Voltage	V_{EBO}		-5	V
Collector Current	I_C		-15	A
Base Current	I_B		-4	A
Collector Power Dissipation	P_C	$T_{CASE} = 25^\circ\text{C}$	160	W
Junction Temperature	T_J		150	$^\circ\text{C}$
Storage Temperature	T_{stg}		-55 to 150	$^\circ\text{C}$

ELECTRICAL CHARACTERISTICS at $T_A = 25^\circ\text{C}$

Characteristic	Symbol	Test Conditions	Min.	Typ.	Max.	Unit
Collector-Cutoff Current	I_{CBO}	$V_{CB} = -260\text{ V}$	-	-	-10	μA
Emitter Cutoff Current	I_{EBO}	$V_{EB} = -5\text{ V}$	-	-	-10	μA
Collector-Emitter Voltage	$V_{(BR)CEO}$	$I_C = -25\text{ mA}$	-260	-	-	V
DC Current Transfer Ratio*	h_{FE}	$V_{CE} = -4\text{ V}, I_C = -5\text{ A}$	40	-	140	-
Collector-Emitter Saturation Voltage	$V_{CE(sat)}$	$I_C = -5\text{ A}, I_B = -0.5\text{ A}$	-	-	-0.5	V
Cutoff Frequency	f_T	$V_{CE} = -12\text{ V}, I_E = 2\text{ A}$	-	35	-	MHz
Output Capacitance	C_{OB}	$V_{CB} = -10\text{ V}, I_E = 0\text{ A}, f = 1\text{ MHz}$	-	500	-	pF

* h_{FE} rating: 40 to 80 (R brand on package), 50 to 100 (O), 70 to 140 (Y).

Performance Characteristics

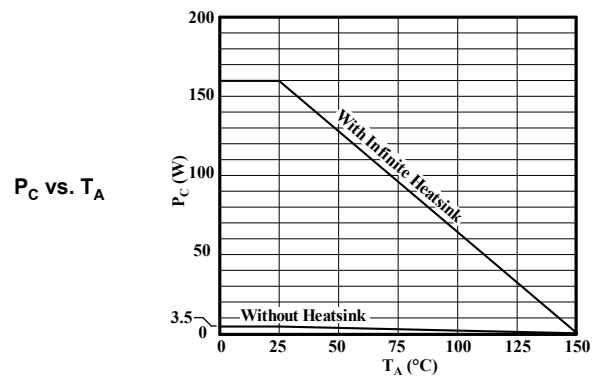
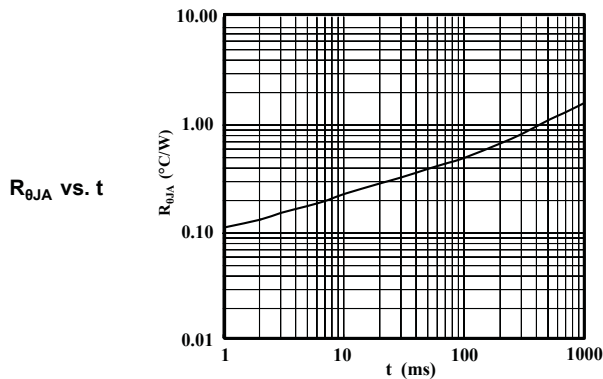
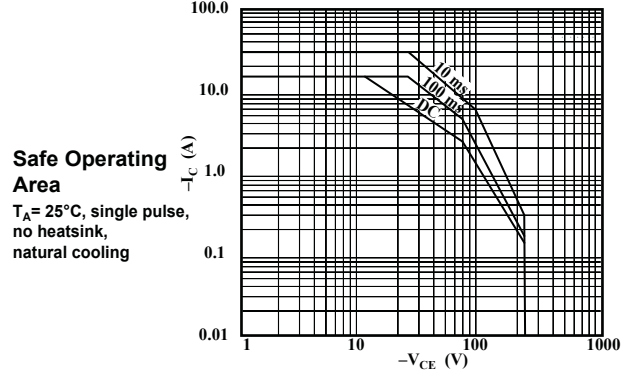
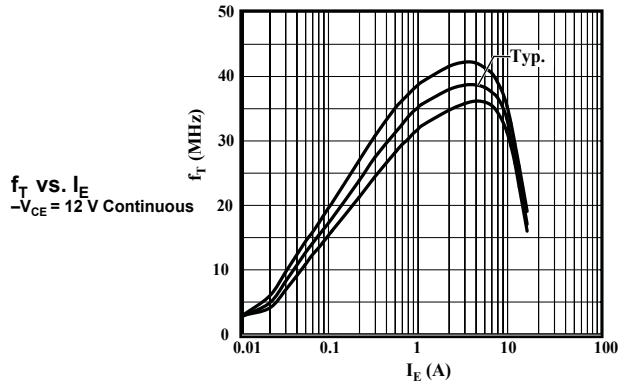
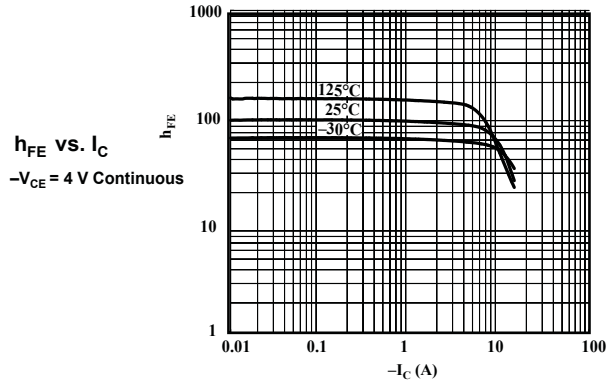
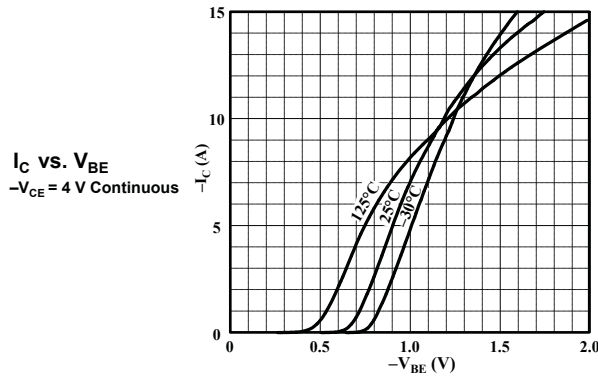
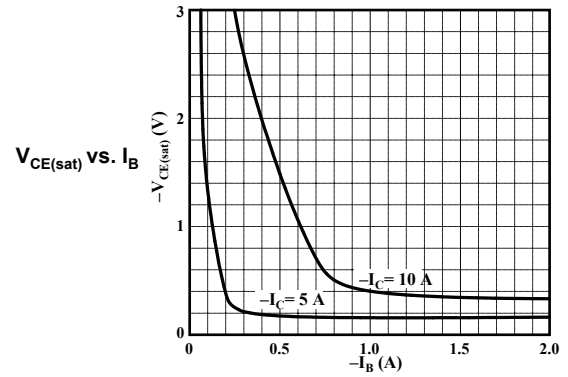
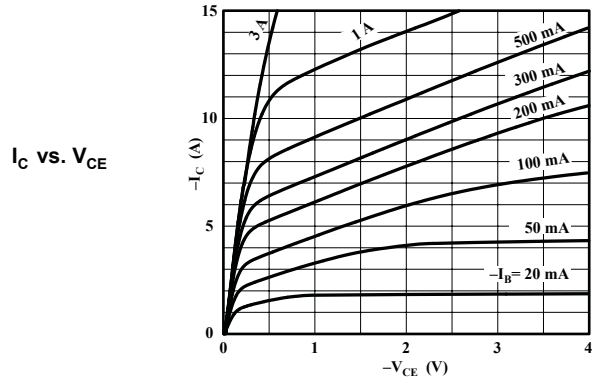

Package Outline Drawing, TO-3P

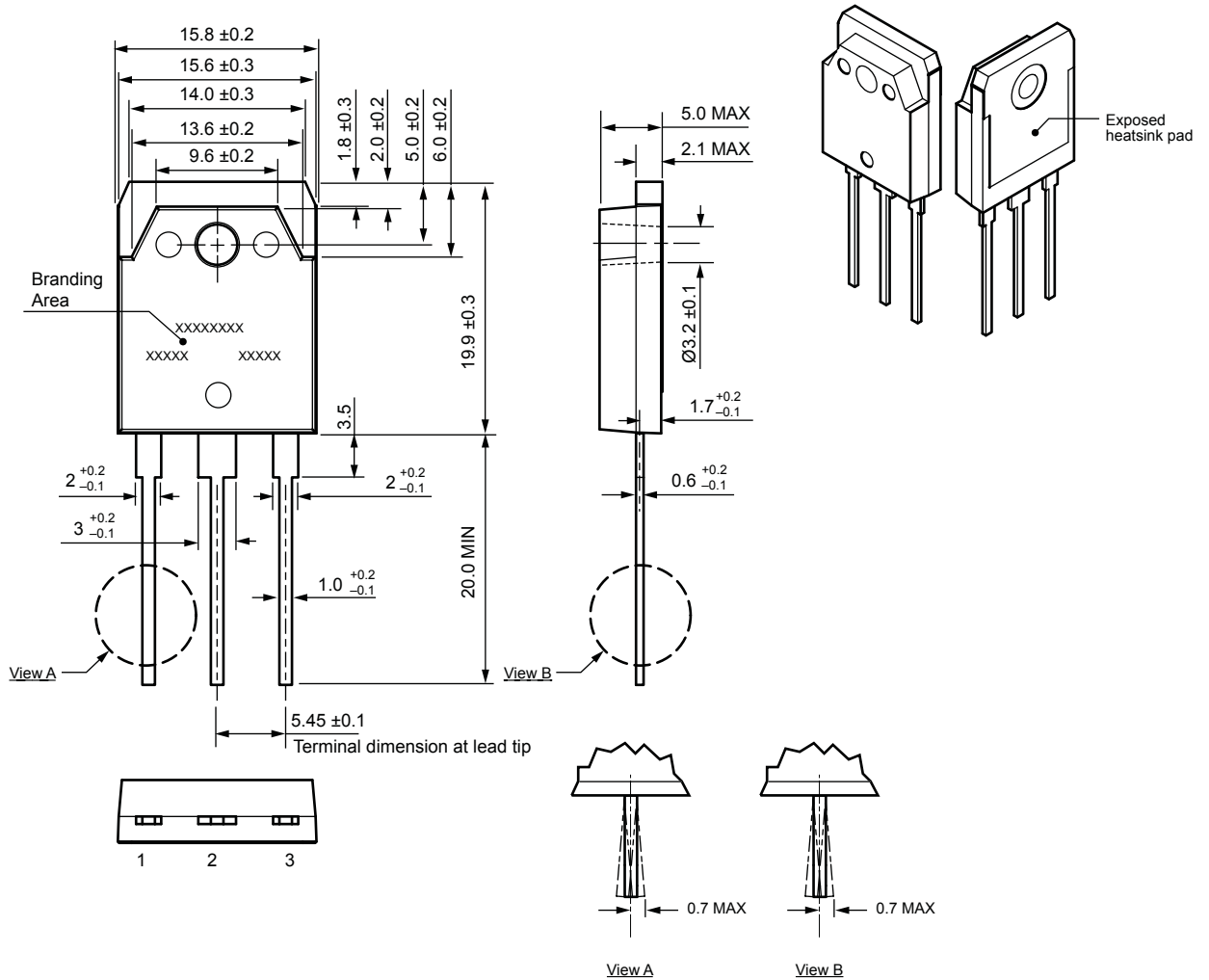

Gate burr: 0.3 mm (max.), mold flash may appear at opposite side
 Terminal core material: Cu
 Terminal treatment: Ni plating and Pb-free solder dip
 Leadform: 100
 Package: TO-3P (M100)
 Approximate weight: 6 g

Dimensions in millimeters

Branding codes (exact appearance at manufacturer discretion):
 1st line, type: A2223A
 2nd line left, lot: YM
 Where: Y is the last digit of the year of manufacture
 M is the month (1 to 9, O, N, D)
 2nd line right, subtype: H
 Where: H is the h_{FE} rating (O, R, or Y; for values see footnote, Electrical Characteristics table)



Leadframe plating Pb-free. Device composition includes high-temperature solder (Pb >85%), which is exempted from the RoHS directive.

Because reliability can be affected adversely by improper storage environments and handling methods, please observe the following cautions.

Cautions for Storage

- Ensure that storage conditions comply with the standard temperature (5°C to 35°C) and the standard relative humidity (around 40% to 75%); avoid storage locations that experience extreme changes in temperature or humidity.
- Avoid locations where dust or harmful gases are present and avoid direct sunlight.
- Reinspect for rust on leads and solderability of the products that have been stored for a long time.

Cautions for Testing and Handling

When tests are carried out during inspection testing and other standard test periods, protect the products from power surges from the testing device, shorts between the product pins, and wrong connections. Ensure all test parameters are within the ratings specified by Sanken for the products.

Remarks About Using Silicone Grease with a Heatsink

- When silicone grease is used in mounting the products on a heatsink, it shall be applied evenly and thinly. If more silicone grease than required is applied, it may produce excess stress.
- Volatile-type silicone greases may crack after long periods of time, resulting in reduced heat radiation effect. Silicone greases with low consistency (hard grease) may cause cracks in the mold resin when screwing the products to a heatsink.

Our recommended silicone greases for heat radiation purposes, which will not cause any adverse effect on the product life, are indicated below:

Type	Suppliers
G746	Shin-Etsu Chemical Co., Ltd.
YG6260	Momentive Performance Materials Inc.
SC102	Dow Corning Toray Co., Ltd.

Cautions for Mounting to a Heatsink

- When the flatness around the screw hole is insufficient, such as when mounting the products to a heatsink that has an extruded (burred) screw hole, the products can be damaged, even with a lower than recommended screw torque. For mounting the products, the mounting surface flatness should be 0.05 mm or less.
- Please select suitable screws for the product shape. Do not

use a flat-head machine screw because of the stress to the products. Self-tapping screws are not recommended. When using self-tapping screws, the screw may enter the hole diagonally, not vertically, depending on the conditions of hole before threading or the work situation. That may stress the products and may cause failures.

- Recommended screw torque: 0.686 to 0.882 N•m (7 to 9 kgf•cm).
- Diameter of Heatsink Hole: < 4 mm. The deflection of the press mold when making the hole may cause the case material to crack at the joint with the heatsink. Please pay special attention for this effect.
- For tightening screws, if a tightening tool (such as a driver) hits the products, the package may crack, and internal stress fractures may occur, which shorten the lifetime of the electrical elements and can cause catastrophic failure. Tightening with an air driver makes a substantial impact. In addition, a screw torque higher than the set torque can be applied and the package may be damaged. Therefore, an electric driver is recommended.

When the package is tightened at two or more places, first pre-tighten with a lower torque at all places, then tighten with the specified torque. When using a power driver, torque control is mandatory.

Soldering

- When soldering the products, please be sure to minimize the working time, within the following limits:
260±5°C 10±1 s (Flow, 2 times)
350±5°C 3±0.5 s (Soldering iron, 1 time)
- Soldering should be at a distance of at least 1.5 mm from the body of the products.

Electrostatic Discharge

- When handling the products, the operator must be grounded. Grounded wrist straps worn should have at least 1 MΩ of resistance from the operator to ground to prevent shock hazard, and it should be placed near the operator.
- Workbenches where the products are handled should be grounded and be provided with conductive table and floor mats.
- When using measuring equipment such as a curve tracer, the equipment should be grounded.
- When soldering the products, the head of soldering irons or the solder bath must be grounded in order to prevent leak voltages generated by them from being applied to the products.
- The products should always be stored and transported in Sanken shipping containers or conductive containers, or be wrapped in aluminum foil.

-
- The contents in this document are subject to changes, for improvement and other purposes, without notice. Make sure that this is the latest revision of the document before use.
 - Application and operation examples described in this document are quoted for the sole purpose of reference for the use of the products herein and Sanken can assume no responsibility for any infringement of industrial property rights, intellectual property rights or any other rights of Sanken or any third party which may result from its use.
 - Although Sanken undertakes to enhance the quality and reliability of its products, the occurrence of failure and defect of semiconductor products at a certain rate is inevitable. Users of Sanken products are requested to take, at their own risk, preventative measures including safety design of the equipment or systems against any possible injury, death, fires or damages to the society due to device failure or malfunction.
 - Sanken products listed in this document are designed and intended for the use as components in general purpose electronic equipment or apparatus (home appliances, office equipment, telecommunication equipment, measuring equipment, etc.).

When considering the use of Sanken products in the applications where higher reliability is required (transportation equipment and its control systems, traffic signal control systems or equipment, fire/crime alarm systems, various safety devices, etc.), and whenever long life expectancy is required even in general purpose electronic equipment or apparatus, please contact your nearest Sanken sales representative to discuss, prior to the use of the products herein.

The use of Sanken products without the written consent of Sanken in the applications where extremely high reliability is required (aerospace equipment, nuclear power control systems, life support systems, etc.) is strictly prohibited.

- In the case that you use Sanken products or design your products by using Sanken products, the reliability largely depends on the degree of derating to be made to the rated values. Derating may be interpreted as a case that an operation range is set by derating the load from each rated value or surge voltage or noise is considered for derating in order to assure or improve the reliability. In general, derating factors include electric stresses such as electric voltage, electric current, electric power etc., environmental stresses such as ambient temperature, humidity etc. and thermal stress caused due to self-heating of semiconductor products. For these stresses, instantaneous values, maximum values and minimum values must be taken into consideration.

In addition, it should be noted that since power devices or IC's including power devices have large self-heating value, the degree of derating of junction temperature affects the reliability significantly.

- When using the products specified herein by either (i) combining other products or materials therewith or (ii) physically, chemically or otherwise processing or treating the products, please duly consider all possible risks that may result from all such uses in advance and proceed therewith at your own responsibility.
- Anti radioactive ray design is not considered for the products listed herein.
- Sanken assumes no responsibility for any troubles, such as dropping products caused during transportation out of Sanken's distribution network.
- The contents in this document must not be transcribed or copied without Sanken's written consent.

Find price and stock options from leading distributors for 2SA2223A on Findchips.com:

<https://findchips.com/search/2SA2223A>

Find CAD models and details for this part:

<https://findchips.com/detail/2sa2223a/Sanken-Electric-Co-Ltd>